AEG ENERGY STORAGE

INSTALLATION MANUAL

**AEG LOW VOLTAGE ENERGY STORAGE UNIT
SERIES: AS-BSL1-8000 / AS-BSL1-12000**

AEG BATTERY PACK AS-BBL1-4000

AEG

AEG ENERGY STORAGE UNIT INSTALLATION MANUAL

Thank you for choosing the reliability of AEG energy storage units.

This installation manual is intended for dealers and installers involved in the planning, installation and commissioning of photovoltaic systems deploying AEG storage units. These instructions provide you with valuable information to ensure that your energy storage unit runs smoothly and achieves optimal yields over its whole lifecycle.

AEG energy storage units are tested and approved by acknowledged independent certification authorities and can only be installed by qualified professional companies.

Please observe the standards and regulations applying to photovoltaic systems in the relevant countries, as well as the rules of the employers' liability insurance associations for accident protection. Failure to comply with these can result in major injuries and damage.

The information provided in this manual is accurate at the time of publication; however, Solar Solutions reserves the right to make changes to product design and technical specification updates at any time without prior notice. Illustrations in this manual are meant to help explain system configuration concepts and installation instructions. The illustrated items may differ from the actual items at the installation location.

Keep this guide in a safe place for further reference as it contains important information for product care, maintenance and disposal.

CONTENTS

1. PRELIMINARY REMARKS	3
1.1 Icons	3
1.2 Product Identification	3
2. Safety	4
2.1 General safety	4
2.4 Grid-tied operation safety	6
3. PRODUCT OVERVIEW	8
3.1 General remarks	8
3.1 Product appearance	8
3.1.1 Energy storage system	8
3.2 Battery module	9
3.2.1 Battery module wiring port	9
3.2.2 CAN communication interface (CAN1 & CAN2)	10
3.2.3 LED indicators	10
3.3 Function scheme	11
3.3.1 Basic scheme	11
3.3.2 Work modes	11
3.4 Technical data of the energy storage system	11
3.5 Technical data of battery module	12
3.6 Operating data	12
BMS (Battery Management System)	12
Operating conditions	13
Reliability and certification	13
4. INSTALLATION	13
4.1 Installation tools	13
4.2 Installation materials	13
4.3 Wire specifications	13
4.4 Installation location	14
4.4.1 Choosing the installation site	14
4.5 Unboxing and package content	14
4.6 Mechanical and electrical installation	15
PV connection	18
Grid and load connection	19
4.7 Warnings	20
5. OPERATION	20
5.1 Operating the AEG battery pack	20
5.2 Switching on/off the AEG energy storage system	21
5.3 Operating the LCD touchscreen	21
LCD position	21
5.3.1 General remarks	21
5.3.2 The main menu	22
5.3.3 Checking system information in the Status menu	22
5.3.4 Checking and adjusting system settings in the Settings menu	23
Selecting the power source; setting the charging / feed-in intervals and speed	23
Choosing how to use stored energy	24
Setting language and time	24
Checking product information	24

5.3.5 Accessing the statistics in the Data menu	25
5.3.6 Checking Fault messages	25
5.4 Advanced settings (for installers only)	26
5.4.1 Setting of battery parameters	26
5.4.2 Setting of grid parameters	26
Charging and Discharging settings of the AEG energy storage system	27
5.4.3 Additional settings	27
6. TROUBLESHOOTING	27
6.1 Battery pack warnings and troubleshooting	27
6.2 Energy storage system warnings and troubleshooting	28
6.2.1 Fault codes	28
6.2.2 Troubleshooting specific faults	29
7. GENERATOR AND AC COUPLING FUNCTION	30
8. PRODUCT END OF LIFE	30
9. DISCLAIMER OF LIABILITY	31
10. CONTACT	31

1.2 Product Identification

Energy Storage System:

Each energy storage system can be identified by means of the following information:

Serial Number

Each storage unit is identified by a unique serial number univocally coupled with a barcode, to be found on the cabinet.

Product Label

The product label of the energy storage unit is placed on the housing. It provides information about the main parameters of the storage unit such as: Product Name Code (PNC), Capacity, PV Input, AC Grid Port Input and Output, Off-Grid AC Output, Battery Data, and further operation parameters.

1. PRELIMINARY REMARKS

1.1 Icons

This section describes relevant warning symbols recurring in the installation and operation manual of AEG energy storage systems. Icons highlight relevant information for the physical and property safety of the user. Compliance to the provided instructions is essential to prevent physical injury and product damage. Below is a list of the icons used in this manual:







Icon	Meaning	Instruction
	Danger	Serious physical injury or even death may occur in case of noncompliance with the requirement (electrical hazard)
	Warning	Physical injury or product damage may occur in case of noncompliance with the requirement.
	Electrostatic discharge	Damage may occur in case of noncompliance with the requirement.
	Hot surface	Product surface may become hot, do not touch
	Note	Useful information for product maintenance and operation is provided

Table 1: Icon meaning



AEG		Product Name Code (PNC)	Product Name Code (PNC)
HOME ENERGY STORAGE SYSTEM			
MODEL (PNC): AS-BSL1-8000			
CAPACITY			
Nominal storage capacity (kWh)	7.68		
Usable storage capacity (kWh)	6.14		
PV INPUT			
Max. recommended DC power (W)	6500		
Max. DC voltage (V)	500		
MPPT voltage range (V)	125-425		
Max. input current (A)	11/11		
Max. short current (A)	16/16		
Number of MPPT trackers	2		
AC GRID PORT INPUT AND OUTPUT			
Grid type	Single phase (L/N/PE)		
AC voltage (VAC)	230		
Max. continuous power (W)	5000		
Max. AC apparent power (VA)	5000		
Max. AC output current (A)	25		
Max. AC input current (A)	25		
Grid frequency/range (Hz)	50		
Power factor range	-0.8 ~ +0.8		
OFF-GRID AC OUTPUT			
Grid type	Single phase (L/N/PE)		
AC voltage (VAC)	230		
Max. continuous power (W)	5000		
Max. AC apparent power (VA)	5000		
Max. AC output current (A)	25		
Max. AC input current (A)	25		
Grid frequency/range (Hz)	50		
Power factor range	-0.8 ~ +0.8		
BATTERY DATA			
Battery type	Lithium (LFP)		
Normal voltage (V)	51.2		
Voltage range (V)	42-58		
Max. charge/discharge current (A)	100		
REGULAR PARAMETERS			
Protective class	Class I		
Ingress protection	IP 20		
Overvoltage category	OV/C (BPO) OV/CII(AC)		
Inverter topology	Non-isolated		
Operating temperature range (°C)	-30 ~ +40		
			



AEG		Product Name Code (PNC)	Product Name Code (PNC)
HOME ENERGY STORAGE SYSTEM			
MODEL (PNC): AS-BSL1-12000			
CAPACITY			
Nominal storage capacity (kWh)	11.52		
Usable storage capacity (kWh)	9.22		
PV INPUT			
Max. recommended DC power (W)	6500		
Max. DC voltage (V)	500		
MPPT voltage range (V)	125-425		
Max. input current (A)	11/11		
Max. short current (A)	16/16		
Number of MPPT trackers	2		
AC GRID PORT INPUT AND OUTPUT			
Grid type	Single phase (L/N/PE)		
AC voltage (VAC)	230		
Max. continuous power (W)	5000		
Max. AC apparent power (VA)	5000		
Max. AC output current (A)	25		
Max. AC input current (A)	25		
Grid frequency/range (Hz)	50		
Power factor range	-0.8 ~ +0.8		
OFF-GRID AC OUTPUT			
Grid type	Single phase (L/N/PE)		
AC voltage (VAC)	230		
Max. continuous power (W)	5000		
Max. AC apparent power (VA)	5000		
Max. AC output current (A)	25		
Max. AC input current (A)	25		
Grid frequency/range (Hz)	50		
Power factor range	-0.8 ~ +0.8		
BATTERY DATA			
Battery type	Lithium (LFP)		
Normal voltage (V)	51.2		
Voltage range (V)	42-58		
Max. charge/discharge current (A)	100		
REGULAR PARAMETERS			
Protective class	Class I		
Ingress protection	IP 20		
Overvoltage category	OV/C (BPO) OV/CII(AC)		
Inverter topology	Non-isolated		
Operating temperature range (°C)	-30 ~ +40		
			

Energy storage system label example

AS-BSL1-8000

AS-BSL1-12000

Icon	Meaning
	Safety warning: electrical hazard
	Wait at least 10 minutes after disconnecting the inverter before touching internal parts
	Product surface may become hot, do not touch

Icon	Meaning
	For proper use read the installation manual
CE	CE marking. The product complies with the CE directives
	EU WEEE mark. Do not dispose of product as household waste.

Explanation of icons on storage unit label

Battery Pack:



Each battery pack can be identified by means of the following information:

Serial Number





Each battery pack is identified by a unique serial number univocally coupled with a barcode, to be found on the housing.

Product Label

The product label of the battery pack is placed on the housing. It provides information about the main parameters of the device such as: Product Name Code (PNC), Battery Type, Capacity, Nominal Voltage and Nominal Energy, Charge, and further operation parameters.

AEG	AEG is a registered trademark and under license from AEG ElectroLux (publ)	Solar Solutions GmbH Brückenstrasse 56, 60596 Frankfurt am Main, Germany +49 69 800 1000 1810 info@aec-industrialsolar.de www.aeg-industrialsolar.de Product assembled in the P.R.C.
Product Name Code	AS-BBL1-4000	
Battery type	Lithium (LFP)	
Capacity	75Ah	
Nominal voltage	51.2V	CE
Nominal energy	3.84kWh	
Charge/discharge current (nominal)	0.25C / 0.5C	
Operating temperature range	-10 ~ 45°C	
Protection class	IP20	
		

Battery pack label example

Icon	Meaning
	Safety warning: electrical hazard
	Electrolytes leak danger
	Risk of explosion
	Heavy, handle with care to avoid injury

Icon	Meaning
	Keep away from fire or ignition sources
	Keep away from children
+ -	Ensure correct polarity connection
	For proper use read the installation manual
	Suitable for recycling through a professional battery recycling company
CE	CE marking. The product complies with the CE directives
	EU WEEE mark. Do not dispose of product as household waste.

Explanation of icons on battery pack label

Please refer to the specific product datasheet on www.aeg-industrialsolar.de for the latest technical data.

2. SAFETY

2.1 General safety

All AEG energy storage units are tested according to international safety regulations.







AEG energy storage units should be installed, maintained, connected and operated by qualified technicians in compliance with all local and national applicable standards, codes and regulations issued by the relevant power suppliers, companies and authorities. Installers bear the risk of all injury that might occur during installation including, without limitation, the risk of electric shock. Check and follow all safety precautions specified even for the other components of the system. Keep children away from the installation site and during transportation, installation and maintenance of the electrical equipment.

2.2 Handling safety

Please observe the following indications when handling the AEG energy storage unit (AS-BSL1-8000 or AS-BSL1-12000) and the AEG battery pack (AS-BBL1-4000).

Look for any visible damage to the package or the product itself. Double-check the order information and the product nameplate to ensure the products are of the ordered type. Check that the package contents are not damaged and that all items listed are present (see 4.5 „Unboxing and package content“). Should you find any issues, contact the shipping company and / or your supplier as soon as possible before attempting product installation.

Take note of the indications displayed on the product packaging. Specifically:

Icon	Meaning
	This side up
	Fragile
	Handle with care
	Do not turn or drop
	Do not stack
	Keep dry

Packaging icon meaning

 Please make sure that the storage system and its components are properly packed and sealed to ensure safe transportation and that the IP20 protection degree is maintained. Ensure that the energy storage system is stored in a dry, clean place and not exposed to water or dust.

 The energy storage unit and the battery pack are heavy. Handle them carefully in order to avoid injuries. At least two people are required to move and install the energy storage system.

To ensure handling, installation and maintenance safety, and to avoid personal injuries, please adopt mechanical protective measures such as wearing protective shoes and work clothes.

 To avoid electric shock, remove metallic rings, watchbands, ear, nose or lip rings or other metallic devices during installation, connection and maintenance of the energy storage system.

2.2.1 Handling the battery pack

 Handle the battery pack carefully as it may leak corrosive electrolyte.

 To avoid the risk of explosion of the battery pack, make sure to observe the following:
Do not make the battery pack undergo strong impacts.
Do not crush or puncture the battery pack.
Do not dispose of the battery pack in a fire.

 To avoid fire risks to the battery pack, please make sure to observe the following:
Do not expose the battery pack to temperatures that exceed 60°C.
Do not place the battery pack near a heat source, such as a fireplace.
Do not expose the battery pack to direct sunlight.
Do not allow the battery connectors to touch conductive objects such as wires.

 To avoid the risk of the electric shock from the battery pack, please make sure to observe the following handling instructions:
Do not disassemble the battery pack.
Do not touch the battery pack with wet hands.
Do not expose the battery pack to moisture or liquids.
Keep the battery pack away from children and animals.

To avoid damaging the battery pack, please make sure to also observe the following handling instructions:
Do not allow the battery pack to come in contact with liquids.
Do not expose the battery pack to high pressures.
Do not place any objects on top of the battery pack.
Do not pull or drag the battery pack, nor step on it.

2.3 Installation safety

Installing solar photovoltaic systems and energy storage devices requires specialized skills and knowledge and can only be performed by qualified technicians (see 2.1 General safety). All electric installations need to comply with the national and local laws and standards.

 For installation, choose a location out of the reach of children or public access. Keep the energy storage system and the battery pack away from the reach of children.

 Ensure you are completely familiar with the indications provided in the instructions manual before attempting installation.

 Do not use the battery pack if it is defective, if it appears to be cracked, broken or otherwise damaged, or if it fails to operate.

 Handling or changing components without following the instructions in this manual may cause personal injury, cause product damage, damage the built-in protections of the inverter and ultimately void the warranty.

 Do not attempt to open, disassemble, repair, or modify the battery pack. The battery pack can only be repaired by AEG service personnel.

Use only installation equipment suitable for a solar electric installation.

 Only use original parts and components.



To avoid damaging the product and voiding the warranty, please ensure that the output voltage of the PV array to be connected is lower than the maximum rated input voltage of the energy storage system.

 The solar PV modules in the PV array are required to comply at least with IEC 61730 class A rating. When exposed to sunlight, the PV array generates dangerous high DC voltages. Installers and operators should carefully follow the instructions in this manual when handling the storage system and avoid hazardous actions that might result in life-threatening situations.

 When exposed to light, solar modules may generate dangerous voltages. Cover the modules completely with a dark opaque material during installation and electrical connection to prevent electricity generation.



 The PV system is by default not grounded. The energy storage system must be grounded before operation. The system is not suitable for the positive or negative grounding systems of solar modules. Ensure the proper grounding of the inverter.

 The electronic components of the energy storage system may be damaged by static electricity. Please take appropriate protective measures to prevent such damages from occurring and voiding the warranty.

  Do not carry out any installation or maintenance when the energy storage system is connected to the power supply. To avoid electric shock during installation or maintenance, turn off the DC switch and AC breaker, and disconnect the DC and AC terminals. Wait at least 10 minutes before carrying out installation or maintenance.

 During operation, the energy storage system or the radiator or its components might reach high temperatures. Make sure that you do not touch them while in operation so to avoid burns. Should you need to touch them, allow them to cool down first.

 Ensure there is no electromagnetic interference from other electrical and electronic equipment at the installation site.

  Do not install the energy storage system on or close to flammable or explosive materials.

Use the battery pack only for the intended purpose in combination with the AEG energy storage system.

Do not insert any foreign objects into any part of the battery pack.

2.4 Grid-tied operation safety

Only qualified electricians are allowed to operate the energy storage system under the permission of local energy authorities.

All electrical connections must meet the electrical standards of the country/region in which the installation is located.

Ensure reliable installation and electrical connection before operation.

 Make sure that the battery polarity is connected correctly.

 Before opening the storage system cover make sure that the storage system is turned off and all the external circuits are disconnected. The electrical parts and components inside the inverter are electrostatic.

2.5 Maintenance safety

Only qualified professionals are allowed to carry out maintenance, inspection and refitting of the energy storage system. If your AEG energy storage unit requires maintenance, please contact your supplier.

Ensure that unauthorized people do not access the maintenance area during maintenance operations.

 Before attempting maintenance, disconnect first all power supplies from the grid to the energy storage system. Disconnect the breakers. Wait at least 5 minutes until the internal parts of the system are discharged.

 Please follow the electrostatic protection norms, and take correct protective measures as there are electrostatic sensitive circuits and devices in the system. Appropriate protective measures are meant to prevent damages to the product and personal injury.

 Only use original parts and components. Do not refit the energy storage system unless authorized.

Restart the energy storage system after solving occurred faults that may affect its safety and performance.

 Do not get near to / touch any metal conductive part of the grid or of the energy storage system, otherwise electric shock, physical injury, death or fire may occur. Always pay attention to warning icons and instructions signaling the possibility of electric shock.

Do not use cleaning solvents to clean the battery pack.

2.6 Response to emergency situations

The battery pack AS-BBL1-4000 is designed to prevent hazards resulting from failures. However, Solar Solutions cannot guarantee for its absolute safety.

 If the battery pack leaks electrolyte, avoid contact with the leaking liquid or gas. Electrolyte is corrosive and contact with it may cause skin irritation and chemical burns.

If you find yourself in any of the below emergency situations resulting from exposure to electrolyte, please take the suggested take promptly:

Inhalation: evacuate the contaminated area, and immediately seek medical attention.

Eye contact: rinse the eyes with flowing water for 15 minutes, and immediately seek medical attention.

Skin contact: wash the affected area thoroughly with soap and water, and seek immediately medical attention.

Ingestion: induce vomiting, and seek immediately medical attention

Fire: in case of fire, always have an ABC or carbon dioxide extinguisher at hand.

 The battery pack may catch fire if heated above 150°C. If a fire breaks out when the battery pack is installed, proceed with the following actions:

- Extinguish the fire before the battery pack catches fire.
- If it is impossible to extinguish the fire but you still have time, move the battery pack to a safe area before it catches fire.
- If the battery pack has caught fire, do not try to extinguish the fire. Evacuate people immediately.

 If the battery catches fire, it will produce noxious and poisonous gases. Do not get close to it.

Wet battery: if the battery pack is wet or submerged in water, do not try to get close to it. Contact your installer/ dealer for technical assistance.

Damaged battery: damaged batteries are dangerous and must be handled with extreme caution. They are not fit for use and may pose a danger to people or property.

If the battery pack seems to be damaged, pack it in its original container, and then return it to your installer or distributor.

 Damaged batteries may leak electrolyte or produce flammable gas. If you suspect such damage, immediately contact your installer/ dealer for advice and information.

3. PRODUCT OVERVIEW

3.1 General remarks

The **AEG energy storage system AS-BSL1-8000 / AS-BSL1-12000** is developed for use with photovoltaic installations. It stores the clean energy produced by photovoltaic installations and releases it flexibly according to the individual home and business needs. The AEG energy storage system can be used for improving energy self-consumption, for peak shaving and as emergency power source.

The AEG energy storage unit features an intelligent power management system and user-friendly controls for the analysis of power data and programming. These functions are managed through a comfortable capacitive touch-screen interface. Its sleek appearance is designed to ensure safety and adaptability to the home environment, which are further enhanced by the safe battery access door and by the adjustable feet for greater stability.

The **battery pack AS-BBL1-4000** is a LiFePO₄ lithium battery unit with BMS (battery management system). Characterized by high energy density and reliability, the battery pack's safety is granted among others by relevant protection functions such as under-voltage, over-voltage, over-current, over-temperature, under-temperature protection. The battery pack further features CAN communication. In conjunction with the AEG energy storage system, the battery pack can also function as uninterruptible power supply (UPS) and work within a micro-grid.

3.1 Product appearance

3.1.1 Energy storage system

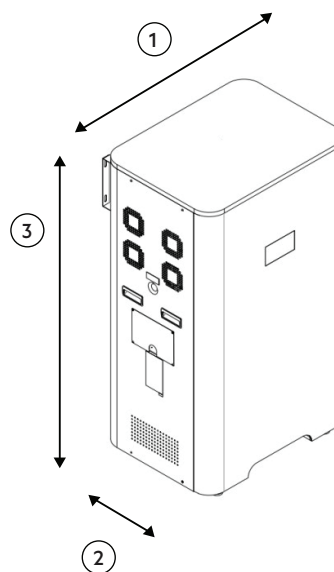

Item	Description	Size	
		AS-BSL1-8000	AS-BSL1-12000
1	Width	750 mm	
2	Depth	565 mm	
3	Height	1335 mm	
/	Weight	240 kg	300 kg

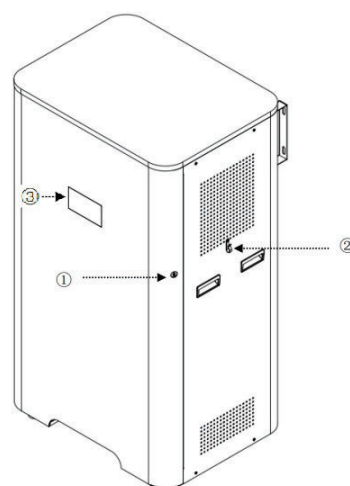

Item.	Description
1	System door lock
2	Door key
3	LCD screen

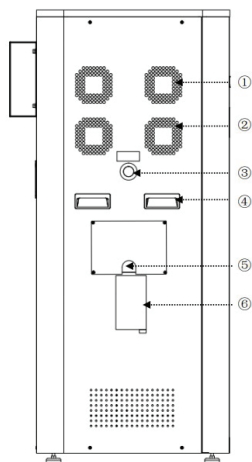

Item.	Description
1	Fan outlet
2	Fan outlet
3	Emergency stop
4	Handle
5	Entry port
6	Label

3.2 Battery module

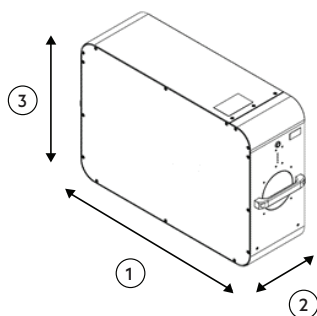

Item	Description	Size
1	Width	678 mm
2	Depth	205 mm
3	Height	436 mm
/	Weight	60 kg

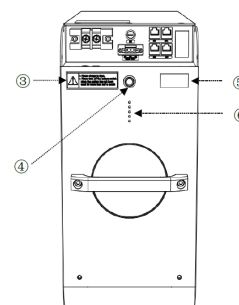
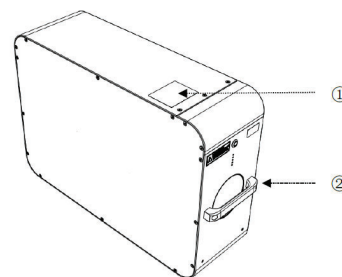

Item.	Description
1	Product label
2	Handle
3	Warning label
4	Push button of BMS power supply
5	Serial number
6	Battery capacity and warning indicator light

3.2.1 Battery module wiring port

The wiring port can be seen in detail after opening the cover plate.

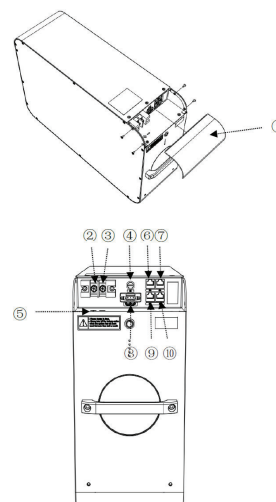

Item.	Description
1	Cover plate
2	Battery + / positive battery pole
3	Battery - / negative battery pole
4	BMS power fuse
5	Battery polarity symbol
6, 7	CAN1 port / for BMS parameter monitoring
8	Remote port / power switch of BMS power supply
9, 10	CAN2 port / for inverter communication

3.2.2 CAN communication interface (CAN1 & CAN2)

Below is the scheme of the CAN communication interface.

CAN1 is used for BMS parameters monitoring
CAN2 is used for inverter communication

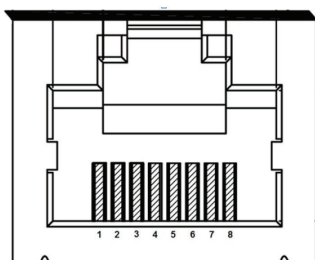

1	2	3	4	5	6	7	8
--	--	--	CANH	CANL	--	--	--

3.2.3 LED indicators

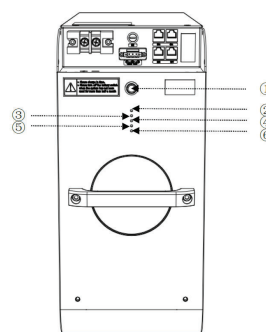

Item	Description	Remark
1	Push button switch	White light
2	100% capacity indicator	Green light
3	75% capacity indicator	Green light
4	50% capacity indicator	Green light
5	25% capacity indicator	Green light
6	Warning indicator	Yellow light



Note:

- 1) Push button switch: the white light will be on after pressing the button.
- 2) Warning indicator: If there is no alarm, the light will always be on. If there is any warning, the light will blink.

3.3 Function scheme

3.3.1 Basic scheme

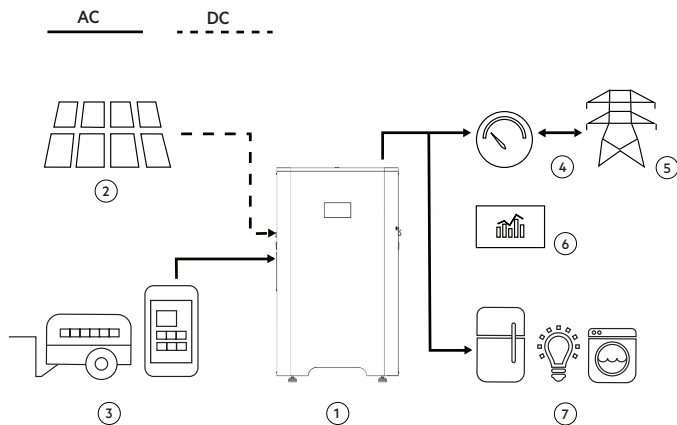

Item.	Description
1	AEG Energy storage system
2	Solar PV panels
3	Diesel generator
4	Meters
5	Grid
6	Monitoring (LCD)
7	House loads

3.3.2 Work modes

The AEG AS-BSL1-8000 / AS-BSL1-12000 energy storage system works in the following modes:

Mode 1 - During daytime, the energy from the photovoltaic plant is directed to charge the battery as a priority. If / When the battery is fully charged, the PV power will be used to power the loads, and the excess power will be fed to the grid.

Mode 2 - During nighttime, the battery powers the loads. If the energy in the battery is not sufficient, the difference will be supplied by the grid.

Mode 3 - If the grid is subject to malfunction, or in regions that are off-grid, the photovoltaic plant and the battery can both concur to power the loads.

Mode 4 - When the battery is low and if power from the photovoltaic plant is unavailable, the energy to charge

the battery and to power the loads will be supplied by the grid.

Mode 5 - A generator can charge the battery bank..

Mode 6 - If the function „Time Of Use“ is on, it will ensure that the power to charge the battery and the power sold to the grid can be balanced.

Mode 7 - The UPS (Uninterrupted Power Supply) Function can ensure that the main loads are still powered even in case of sudden grid failure.

3.4 Technical data of the energy storage system

AS-BSL1-8000 and AS-BSL1-12000

PV Input		
Max. recommended DC power	[W]	6500
Max DC voltage	[V]	500
Nominal DC operating voltage	[V]	360
Start-up voltage	[V]	150
MPPT voltage range	[V]	125-425
V _{DC} range at full power	[V _{DC}]	250-425
Max.input current	[A]	11/11
Max.short current	[A]	16/16
Number of MPPT trackers		2
Strings per MPPT tracker		1/1
AC Input & AC Output		
Normal Voltage	[V _{AC}]	230, Single phase (L/N/PE)
Frequency	[Hz]	50 / 60
Max. AC output current	[A]	25
Max. AC input current	[A]	25
Max. continuous power	[kW]	5
Power factor range		-0.8 ~ +0.8
Off-Grid AC Output		
Normal Voltage	[V _{AC}]	230, Single phase (L/N/PE)
Frequency	[Hz]	50 / 60
Max. AC output current	[A]	25
Max. continuous power	[kW]	5

Peak power		1.5 times of Max. continuous power (10S)	
Power factor range		-0.8~+0.8	
Storage Data			
		AS-BSL1-8000	AS-BSL1-12000
Battery type		Lithium (LFP)	
Number of battery modules		2	3
Nominal storage capacity	[kWh]	7.68	11.52
Usable storage capacity	[kWh]	6.14	9.22
Battery capacity	[Ah]	150	225
Normal voltage	[V]	51.2	
Voltage range	[V]	42-58	
Max. charge current	[A]	100	
Max. discharge current	[A]	100	
DOD		80%	
Cycle life		6000	
Regular parameters			
Protective class		Class I	
Overvoltage category		OVC II (PV), OVCIII (AC main grid)	
Display	[°C]	7" graphic LCD	
Communication		WIFI, CAN	
Operating temperature range	[°C]	-10~+40 (>45° derating)	
Storage stability range	[°C]	-20~+60	
Relative humidity		0~95%	
Altitude	[m]	<2000	
Cooling methods		Forced airflow	
Ingress protection		IP20	
Condition		Indoor conditioned	
Certificates: IEC/EN 62109-2:2011; IEC/EN 62109-1:2010; Low Voltage Directive 2014/35/EU; EN 61000-6-1: 2007; EN 61000-6-3: 2007/+A1: 2011; EMC Directive 2014/30/EU; CE-LVD EN 62477-1: 2012+ALL: 2014; RoHS Directive 2011/65/EU and (EU)2015/863; EU REACH Regulation No 1907/2006 Article 33(1)			
Warranties			
For the latest warranties please refer to: www.aeg-industrialsolar.de			

3.5 Technical data of battery module

Electrical characteristics		
Battery type		LFP
Total energy capacity	[kWh]	3.84
Usable energy capacity	[kWh]	3.07
Battery capacity	[Ah]	75
Voltage range / usable..v.r.	[V]	48~57.6
Nominal voltage	[V]	51.2
Charge current (recommended)	[A]	37.5 A
Discharge current (recommended)	[A]	37.5 A
Max. continuous charge current	[A]	50
Max. continuous discharge current	[A]	50
DOD		80%
Internal resistance	[mΩ]	≤60
Cycle life at 25°C (under standard charge conditions, charge 0.2°C, discharge 0.2°C)		≥6000
DC disconnect		Contacteur
Warranties		
For the latest warranties please refer to: www.aeg-industrialsolar.de		

3.6 Operating data

BMS (Battery Management System)

Power consumption (work)	[W]	<3
Power consumption (sleep)	[mW]	<100
Communication	CAN	
Monitoring parameters	System voltage, system current, cell voltage, cell temperature	
Protection	Overvoltage, undervoltage, overcurrent, overtemperature, undertemperature	

Operating conditions







Installation Location		Indoor
Operating Temperature	[°C]	-10~45
Operating Temperature (Recommended)	[°C]	15~30
Storage Temperature	[°C]	-20 ~60
Humidity	[%]	5~95
Altitude	[m]	Max. 2000
Cooling		Natural convection







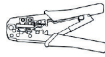

Reliability and certification

Certificates (cell)	UL1642
Certificates (battery module)	IEC62619 / UL1973
Transportation	UN38.3
Ingress rating	IP20

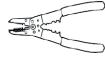
4. INSTALLATION

4.1 Installation tools

Item	Description
	Marking pen
	Impact drill (\varnothing 12 mm)
	Steel tape
	Torque wrench (Opening size:13mm)
	Phillips-screwdriver (M6,M8)
	Straight screwdriver
	Hexagon wrench

Item	Description
	Crimping tool
	Wire cutters
	Wire strippers
	Multimeter
	Safety (insulated) gloves
	Safety goggles
	Dust mask
	Safety shoes

i Note: For specific requirements such as the narrowest maintenance channel, escape route, etc., please refer to the applicable standards of the country/ region where the project is located.

Use properly insulated tools to prevent accidental electric shock or short circuits.

4.2 Installation materials

The below installation material should be arranged by the installer for the installation of the battery pack:

- Charging cables
- Network cable

4.3 Wire specifications

Energy storage system:

In order to standardize the specifications of AC and DC connectors or terminals of the compatible inverters, please make sure to follow the below requirements for

connecting the AC and DC wires of the corresponding inverter types:

Grid & Load side	PV Side
Recommended: Ø 6 mm ² wire	Recommended: Ø 6 mm ² wire

Battery pack:

Please make sure to follow the below requirements for the connecting wires of AS-BBL1-4000:

Battery wire	Communication cable	Remote wire
Recommended: Ø 16 mm ² wire with double insulation	Recommended: standard communication cable with shielding function	Recommended: Ø 0.5 mm ² of Teflon wire

4.4 Installation location

In order to ensure good ventilation of the energy storage system, please ensure there is enough clear space around the system during installation as per the following recommendations.

Position	Min.space	Remarks
Side space	100 cm	Keep a 100 cm clearance on either side of the AEG system
Back space	10 cm	This side needs to be installed against the wall

4.4.1 Choosing the installation site

The cabinet hosting the energy storage system is IP20 and suitable for installation in dry, dust-free environments. According to EMC standards, the system is designed to meet the installation requirements in a home environment.

Select the installation site according to the following requirements:

- The installation site should be well ventilated and

sheltered from direct sunlight, rain and snow;

- The building is designed to withstand earthquakes
- The location should not be in proximity of the sea, to avoid salt water and humidity.
- Ensure there are no corrosive gases at the installation site, including ammonia and acid vapor.
- Ensure there are no flammable or explosive materials at the installation site or nearby.
- The floor of the installation site must be dry and flat. Under no circumstance there should be water on the ground in proximity of the energy storage system. Ensure that the ground level is levelled and can fully carry the weight of the energy storage system.
- The installation site should be clean.
- Ensure enough clear space between the front, rear, left and right, top and wall of the energy storage system to ensure good ventilation and heat dissipation, and to provide space for installation, maintenance, and safe escape.
- The ambient temperature of the installation site should range between -10 °C and 40 °C; the relative temperature should range between 4% to 100 %.



Note: If the ambient temperature is outside of the operating range, the battery pack will go in self-protection mode and stop operating. The optimal temperature range for the battery pack to operate is between 15°C and 30°C degrees. Frequent exposure to harsh temperatures may deteriorate the performance and lifetime of the battery pack. For this reason, it is recommended that temperature and humidity stay at a constant level.

4.5 Unboxing and package content

Before installing the product, please carry out a first check of the package and the package content as described in 2.2 „Handling safety“.

Energy storage system package content

The package content of your AEG energy storage system includes:

Item	Name	Qty.
1	System cabinet	1
2	Battery module	2 (AS-BSL1-8000) 3 (AS-BSL1-12000)
3	Key	1
4	Screws-M6*12	14

Item	Name	Qty.
5	Screws-M5*8	1
6	Screws-M4*6	6
7	Expansion bolts-M8*100	4
8	Module mounting bracket	2
9	Wall mounting bracket	2
10	CAN1 communication wire	1
11	CAN2 communication wire	1
12	Wrench 3#	1
13	PV connector	2
14	PV connector removal tool	1
15	RJ45 terminal	2
16	Current sensor	1
17	User manual	1

AS-BSL1-12000

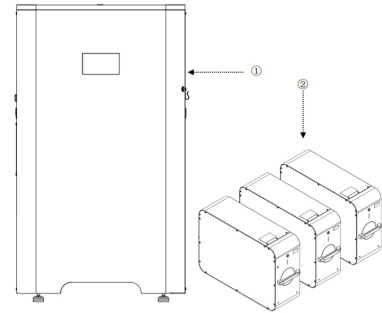

Item.	Description
1	System cabinet
2	Battery modules

Battery pack package content

The package content of the AEG battery pack includes:

Item	Name	Qty.
1	Battery pack AS-BBL1-4000	1
2	Fuse	1
3	Remote port connector	1
4	Hexagon wrench	1

4.6 Mechanical and electrical installation

Step 1: unbox the energy storage system, consisting of the cabinet (1) and battery modules (2). Put the cabinet and battery modules upright and check for any damage before proceeding to installation (see 2.2 „Handling safety“).

AS-BSL1-8000

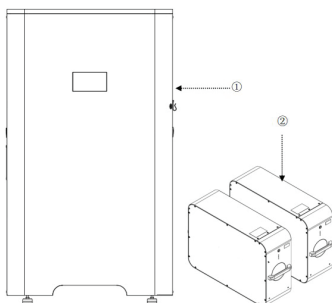

Step 2: Install the cabinet against the wall.

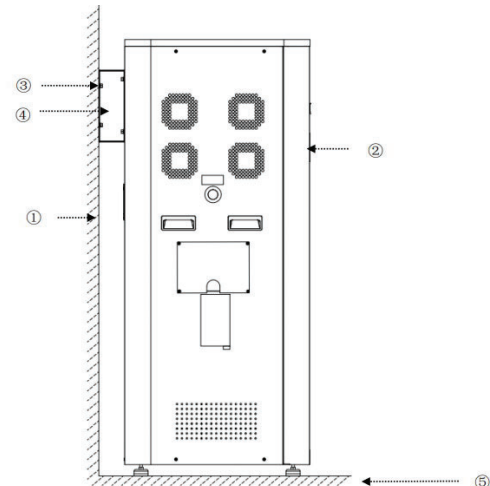

Item.	Description
1	Wall
2	Cabinet
3	Expansion screw
4	Fixing bracket
5	Floor

Step 3: Open the door of the system cabinet, and open the case of the battery module.

AS-BSL1-8000

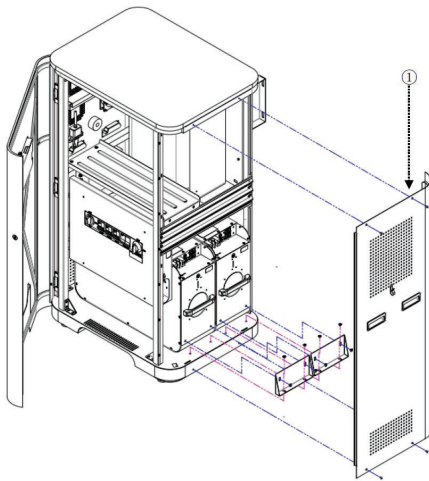

AS-BSL1-12000

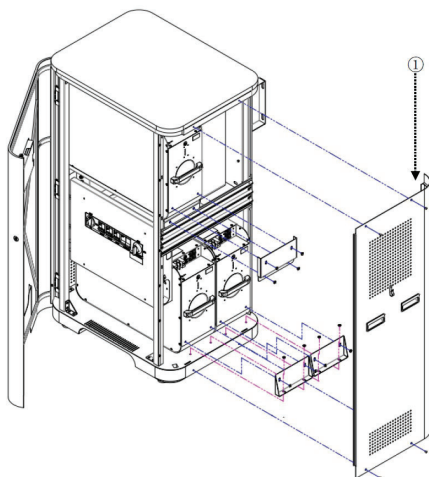

AS-BBL1-4000 (battery pack)

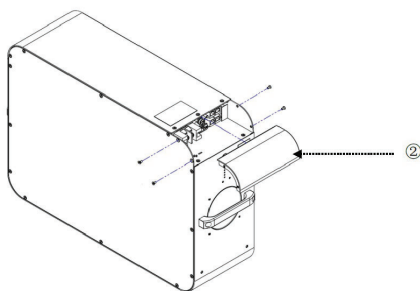

Step 4: Push the battery module into the system, lock the battery cable and plug in the CAN communication & Remote wire.

AS-BSL1-8000

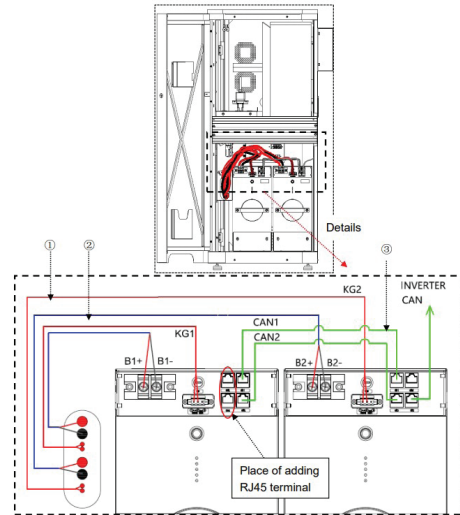

AS-BSL1-12000

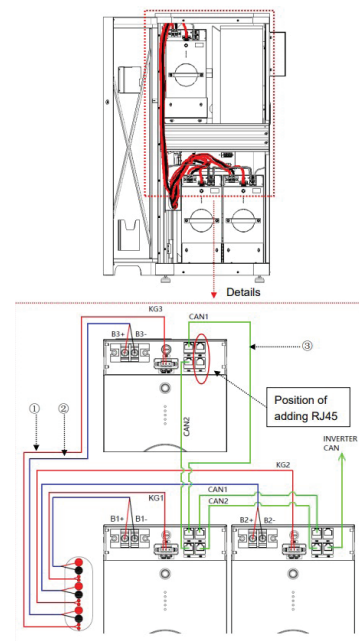

i Note: a RJ45 terminal on CAN1 & CAN2 BUS communication wire needs to be added in order to prevent communication interference. The above pictures show the position where the RJ45 terminal needs to be added in the AS-BSL1-8000 and AS-BSL1-12000 systems respectively. The RJ45 terminal can be found in the accessories, details see below:

Item.	Description
1	System cabinet
2	Battery module case



RJ45 terminal

CAN communication wiring of more battery units connected in parallel

Unit1:CAN1 needs to be connected to Unit2:CAN1 with the communication wire
 Unit1:CAN2 needs to be connected to Unit2:CAN2 with the communication wire.
 Unit2:CAN2 is connected to the inverter with the communication wire.

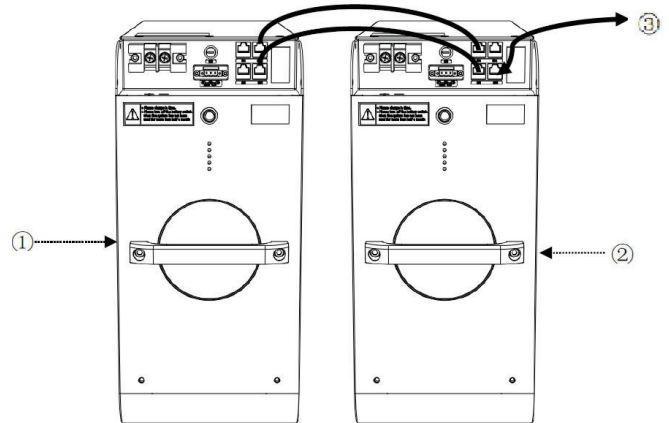

Item.	Description
1	Remote wire
2	Battery wire
3	CAN communication wire



Note:

1) All CAN1 lines for the internal communication of the battery units are connected in parallel.

2) All CAN2 for external communication (between the battery unit and the inverter) are connected in parallel; then CAN2 is connected to the inverter

Single battery unit CAN communication wiring:

CAN2 is connected to the inverter with the communication cable.

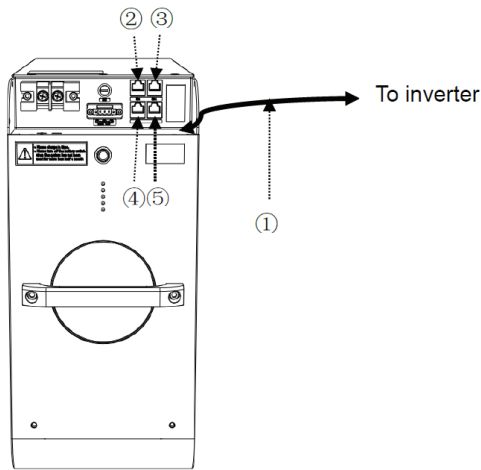

Item.	Description
1	Unit1 (AS-BBL1-4000)
2	Unit2 (AS-BBL1-4000)
3	To the inverter

Electrical connection of the battery pack

For connection of a single battery pack to the inverter:

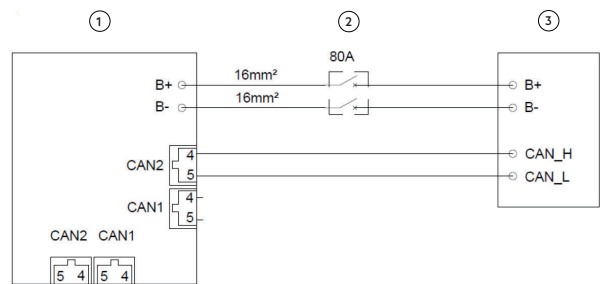

Item.	Description
1	Communication cable
2, 3	CAN1 port; PIN4: CANH / PIN5: CANL
4,5	CAN2 port; PIN4: CANH / PIN5: CANL

Item.	Description
1	Battery pack
2	Breaker
3	Inverter

For connection of a multiple battery packs to the inverter:

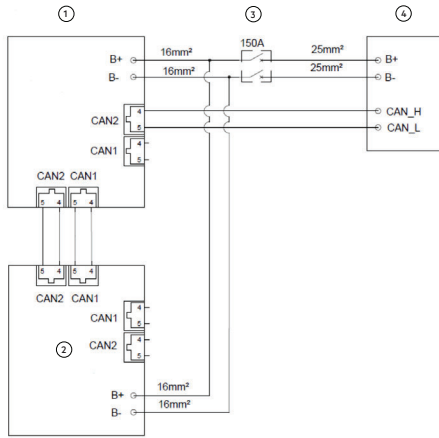

Step 6: External wiring (PV/Grid/Load)

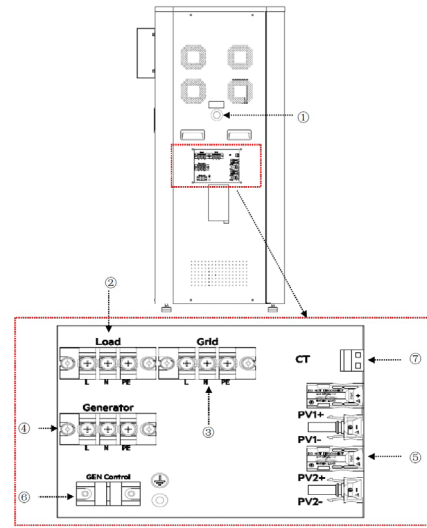

Item.	Description
1,2	Battery pack
3	Breaker
4	Inverter

Item.	Description
1	Emergency stop
2	Load connector (Remark: Back-up load connector)
3	Grid connector
4	GEN connector
5	PV connector
6	GEN control port
7	CT connector

Step 5: Fix the battery module and close the cabinet.

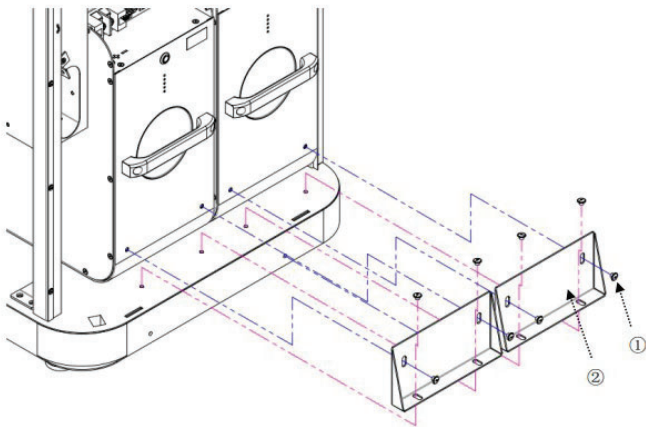

Item.	Description
1	M6*12 combination screw
2	Fixing bracket

PV connection

⚠ Only solar PV systems that comply with the local safety laws and regulations and with the technical parameters specified in this manual are suitable for being connected to the AEG energy storage system.

To connect the photovoltaic system to the AEG energy storage system, a DC connector specifically designed for connection with storage systems must be used. Using other connectors / connection devices without explicit authorization from Solar Solutions may result in damage to the AEG energy storage system, unstable operation or fire, for which Solar Solutions will not take any direct or joint liability.

Notes:

- Recommended wire for PV connection: Ø 4mm².
- PV terminal crimping: recommended torque

3.6–4.6 N•m.

- The maximum open circuit voltage of each PV string should never be higher than the maximum input voltage of the energy storage system.
- Do not connect the PE wire (ground wire) to the positive and negative poles of the PV strings, otherwise it will cause damage to the energy storage system.
- Ensure that the PV string polarity matches the PV connector, otherwise the energy storage system will be damaged.
- To avoid electrical hazard, the insulation resistance of the PV panel to the ground should be greater than the safety regulation.
- Ensure that the wires of the cable correspond to the connector terminals, and tighten the screws. The crimping torque of the screws should be 1.5–2.5 N•m.
- Use a multimeter to measure the voltage of the DC input string, verify the polarity of the DC input cable, and ensure that the voltage of each string is within the allowable range of the system.

terminals, fasten them, and tighten the screws. The crimping torque is 1.5–2.5 N•m.

- Connect the three wires L, N, and PE of the load to the corresponding load terminals, fasten them, and tighten the screws. The crimping torque is 1.5–2.5 N•m.

Here below is a scheme of the storage system's electrical connection within the whole PV installation

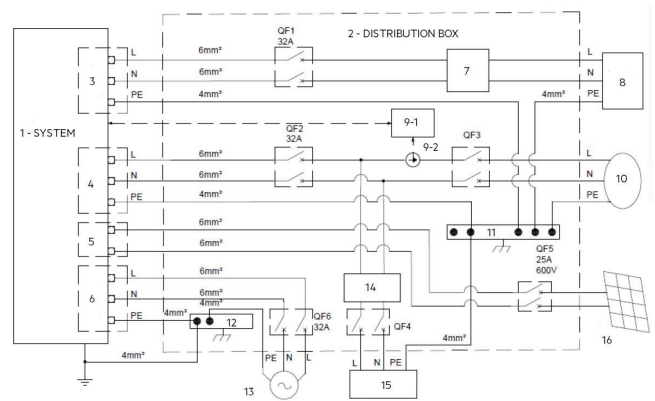

Grid and load connection

 Only AC transmission cables that comply with the local safety laws and regulations and with the technical parameters specified in this manual are suitable for being connected to the AEG energy storage system.

The following table shows the recommended wire specifications for safe system operation:

Grid side.	Load side
Recommended: Ø 6 mm ² wire	Recommended: Ø 6 mm ² wire

Notes:

- Terminal crimping of L/N/PE wires: recommended torque 3.6–4.6 N•m.
- Before connecting the AC power grid cable to the energy storage system, lightning protection and short circuit protection measures must be taken in accordance with the local electrical safety regulations. The PE cable (grounding cable) of the energy storage system must be reliably grounded.
- Connect the three wires L, N, and PE of the single-phase public power grid to the corresponding AC

Item.	Description
1	System
2	Distribution box
3	Back-up loads
4	On-grid
5	PV
6	Generator
7	RCD
8	Back-up loads
9-1	Limit
9-2	CT
10	Grid
11	E-bar
12	E-bar
13	Generator
14	RCD
15	Normal loads
16	PV

Notes: CT direction: towards grid

CT connection

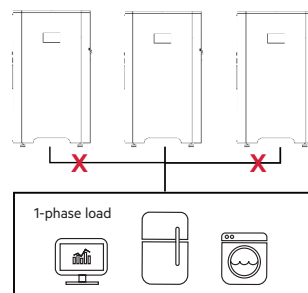
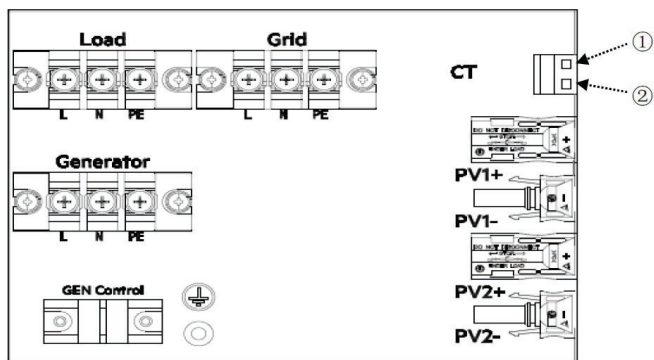

⚠ A single PV string cannot be connected to two or more AEG energy storage systems.

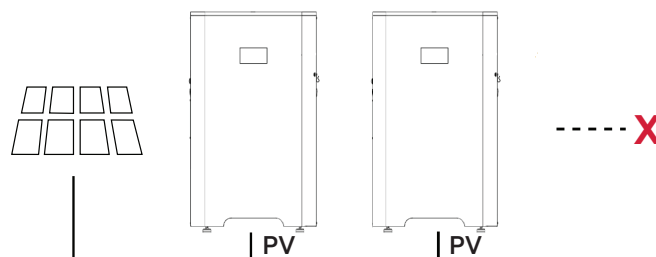

⚠ The UPS (Uninterruptible Power Supply) cannot be connected to the grid.

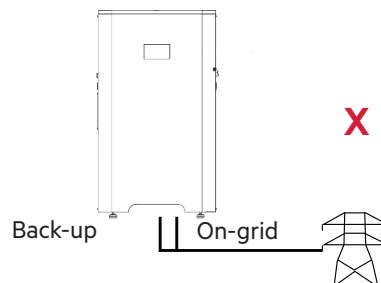

Item.	Description	Remark
1	CT connector	Connect to black CT wire
2	CT connectorx	Connect to white CT wire
3	CT	

4.7 Warnings

⚠ The AEG energy storage system does not support parallel (three- and single-phase) operation on the AC-backup. Parallel operation of the AEG storage system will void the warranty.

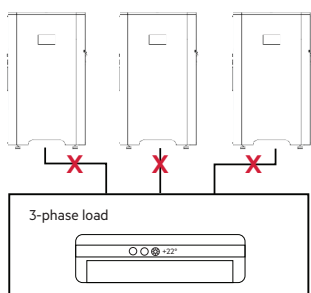

⚠ The AEG energy storage system must be grounded. Failure to do so might cause damage to the product and severe personal injuries.

⚠ It is not recommended to connect air conditioners and water pumps with the AEG energy storage system AS-BSL1-8000 / AS-BSL1-12000.

5. OPERATION

5.1 Operating the AEG battery pack

There are two ways to operate the AEG battery pack AS-BBL1-4-000:

Method 1: Short PIN2 and PIN3 of Remote port first, then press the metal button switch. The battery pack will start to work within 25 seconds. If there is no communication input, after 5 minutes it will stop to function.

Method 2: Install a switch between PIN1 and PIN2 on the Remote port. When the switch is turned on, the battery pack will start to work within 25 seconds. If there is no communication input, after 5 minutes it will stop to function.

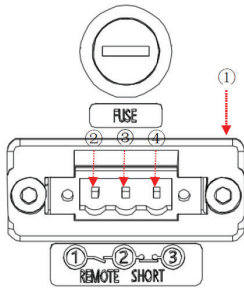

Item.	Description
1	Remote port1
2	PIN1 of Remote port
3	PIN2 of Remote port
4	PIN3 of Remote port

5.2 Switching on/off the AEG energy storage system

Switching on: open the door, and turn on the switches of Load/Grid/Battery/Remote.

Turn off: Open the door, and turn off the switches of Load/Grid/Battery/Remote.

Please refer to the below picture to locate the position of the switches:

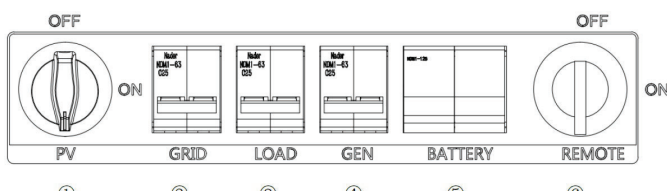

Item.	Description
1	PV switch
2	Grid breaker
3	Load breaker (remark: back-up load)
4	GEN breaker
5	Battery breaker
6	Remote switch

5.3 Operating the LCD touchscreen

LCD position

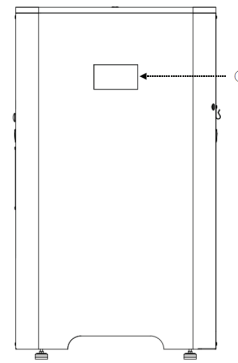

Item.	Description
1	Touchscreen LCD panel

5.3.1 General remarks

Through the LCD display you will be able to monitor the functioning of your AEG energy storage system and adjust its settings. The LCD display gives you access to a menu consisting of different sections, each featuring sub-menus.

Some of the advanced settings need to be carried out necessarily by the installer. These are explained in detail in „5.4 Adjusting the settings - for installers only“.

Some settings require the input of a password. The default password is „12345“.

When a sub-menu or a function requires the input of a password, the following interface will be displayed:

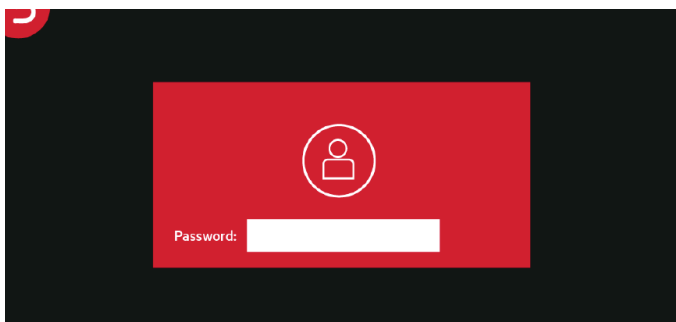

Changing the parameters of the AEG energy storage system will require confirming the operation as shown in the below interface.

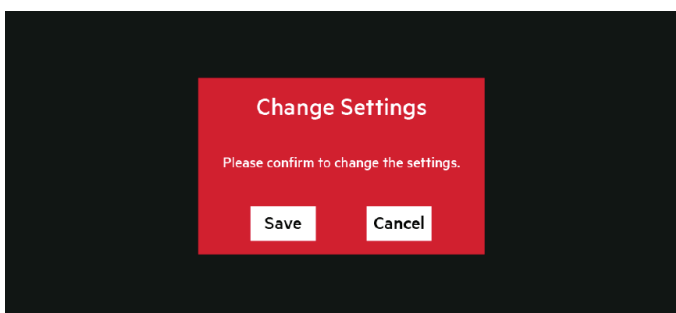

In the following section you will find detailed information on each section and sub-menu, and how to set the parameters of the AEG energy storage system.

5.3.2 The main menu

The main menu includes 5 sections: Status, Settings, Data, Production Information, and Battery Capacity.

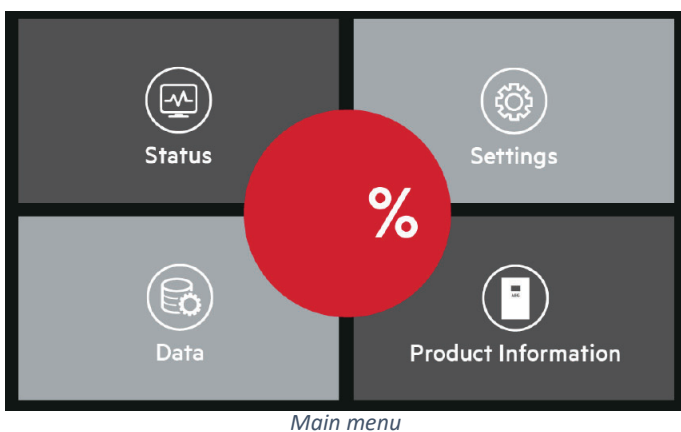

5.3.3 Checking system information in the Status menu

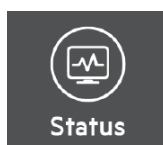

The „**Status**“ menu displays informations such as: PV information, Load information, Grid information, and Battery information

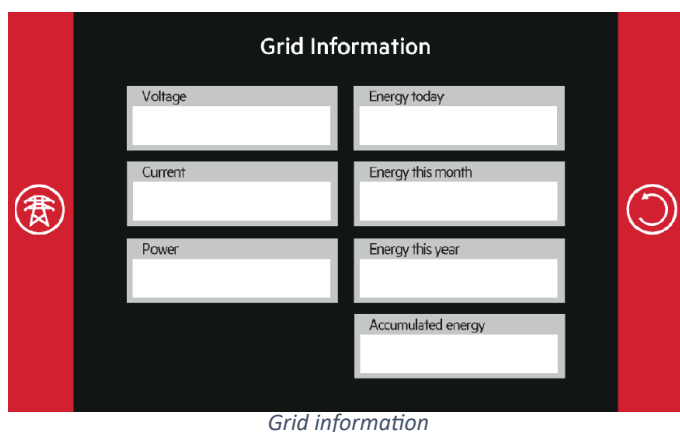
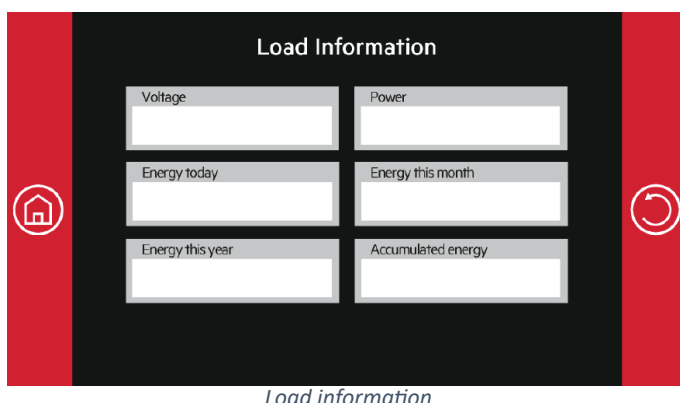
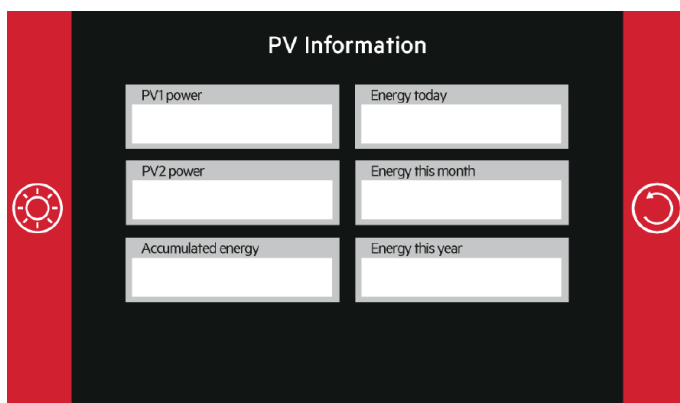

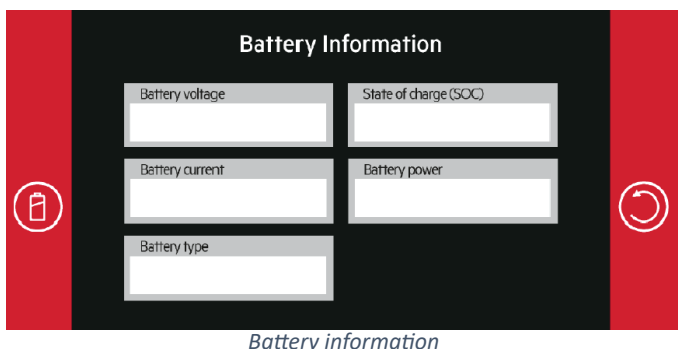

Battery information

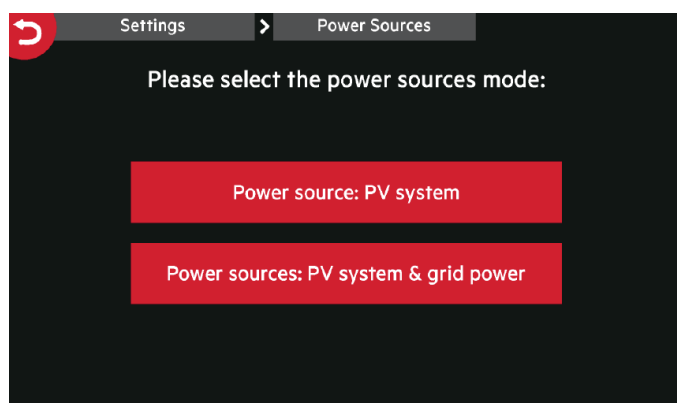

Power source mode

5.3.4 Checking and adjusting system settings in the Settings menu



The „**Settings**“ menu allows you to adjust the settings of the AEG energy storage system.

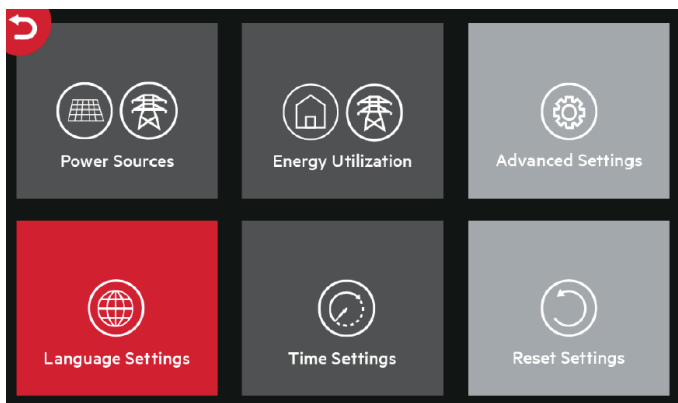

"Settings" menu

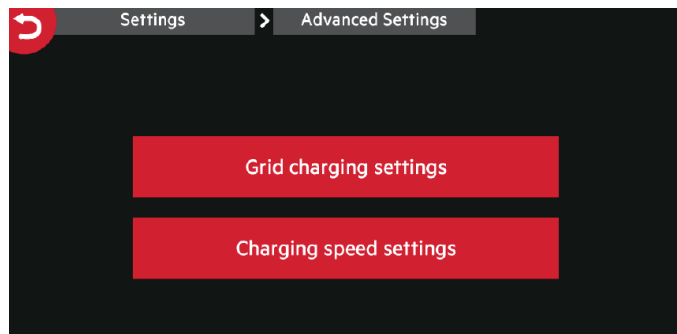

Charging setting

Selecting the power source; setting the charging / feed-in intervals and speed



The „**Power Sources**“ sub-menu will allow you to select the power source. If you wish to only charge the battery from the PV plant, select „Power Source: PV system“.

If you want the storage system to rely both on the grid and the PV plant to charge the battery, select „Power source: PV system and grid power“.

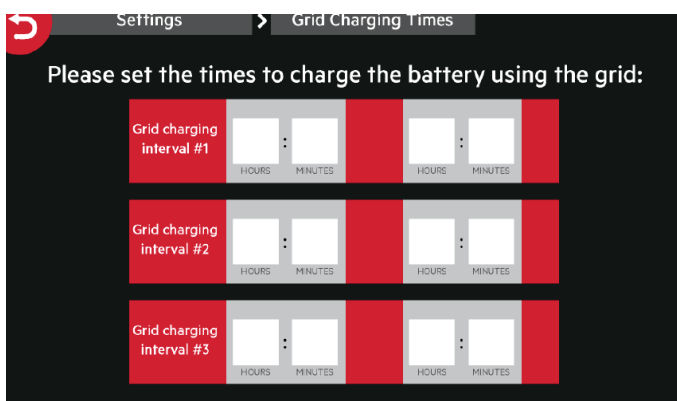

Charging times using the grid

The speed of charging can also be adjusted. The initial default charging speed is „Regular/economy mode (20A)“. Low current charging is instrumental to extend the battery life; „Super charging mode“ is only for occasional use.

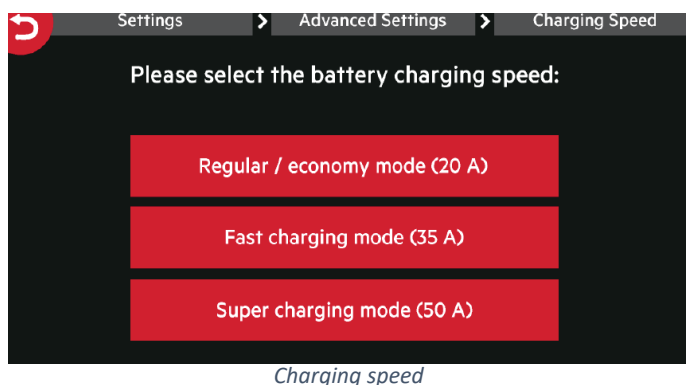

Charging speed

Choosing how to use stored energy

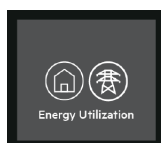

The „**Energy Utilization**“ sub-menu will allow you to select the use of the stored energy.

If you do not wish that the battery feeds back energy to the grid, select „Use of energy for house load only“. Nothing else has to be adjusted then..

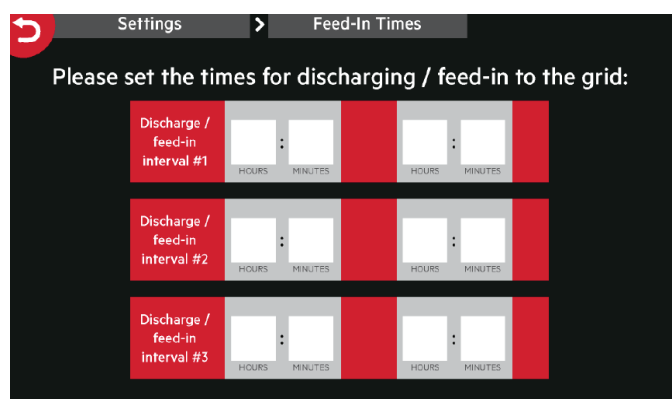

Energy utilization

The section „Feed-in times“ allows you to adjust the intervals at which you wish to discharge the battery by feeding the energy to the grid.

If the generated energy should be used for house load and grid feed-in, please select „Use of energy for house load & grid feed-in“. The time intervals for this have then to be adjusted.

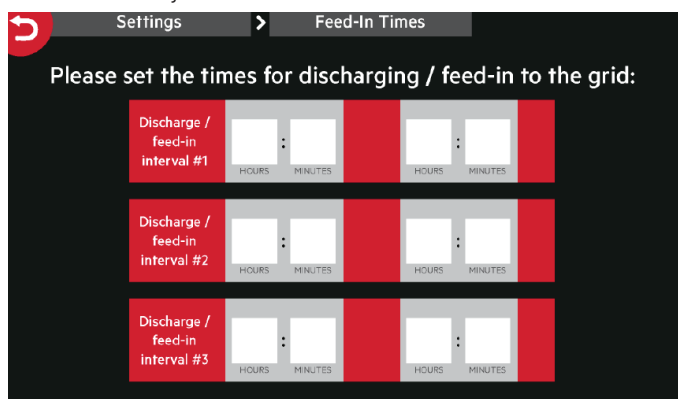

Feed-in times

Setting language and time

The sub-menu „**Language Settings**“ allows you to choose the system languages from a set of given languages (default: English).

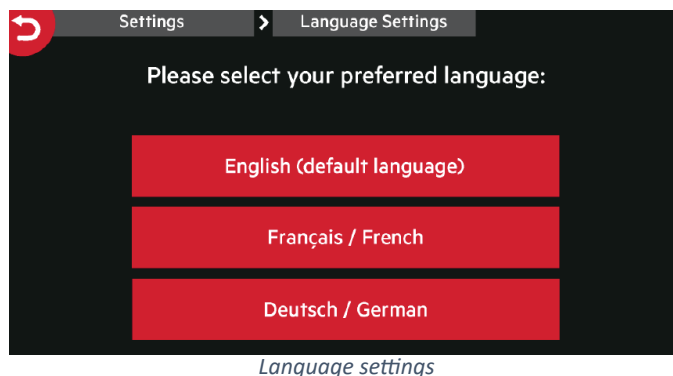

Language settings

The sub-menu „**Time and date**“ allows you to set a different time and date than the default one. Please make sure to set the local time and date immediately after installation, as other parameters (such as charging time, discharging time etc) depend on them..

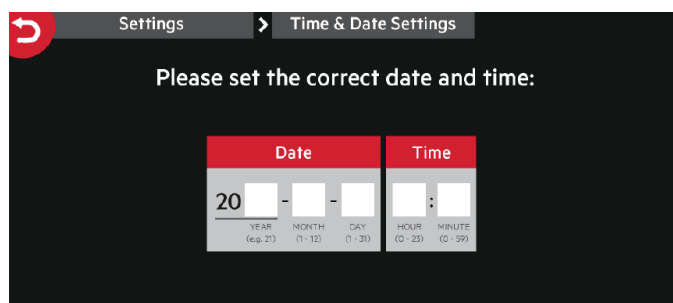

Date and time settings

Checking product information

In the section „Product information“ you can find specific system information such as system PNC (Product Name Code) and version, inverter and battery pack version.

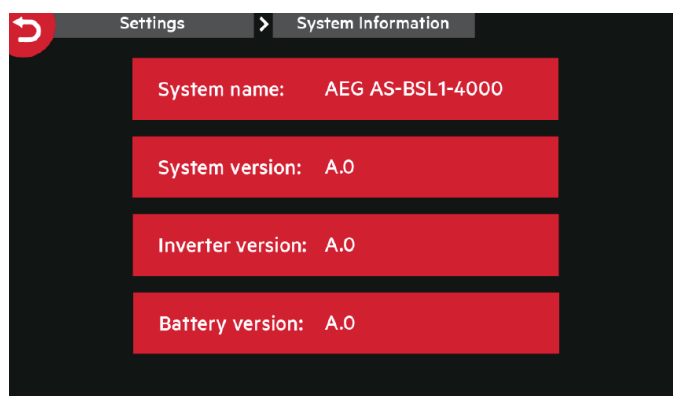

System information

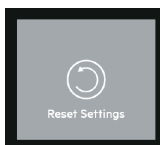
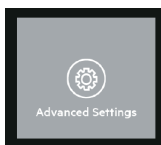

The „Advanced settings“ and „Reset settings“ sub-menus within the „Settings“ menu shall be operated by installers.

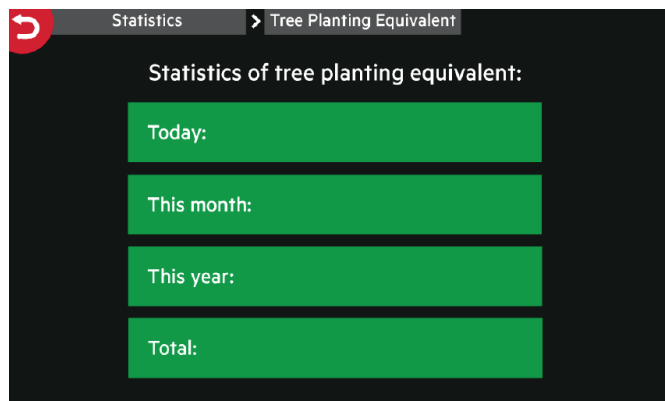

Tree planting equivalent

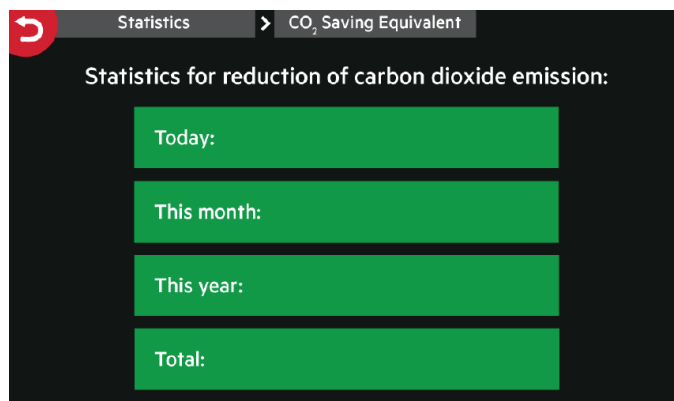

CO₂ saving equivalent

5.3.5 Accessing the statistics in the Data menu

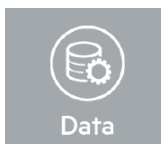

The „Data“ menu displays statistics related to energy generation from the PV plant, grid feed-in, and environmental statistics.

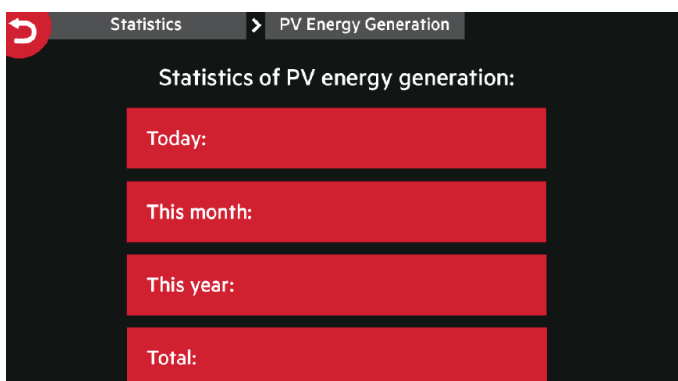
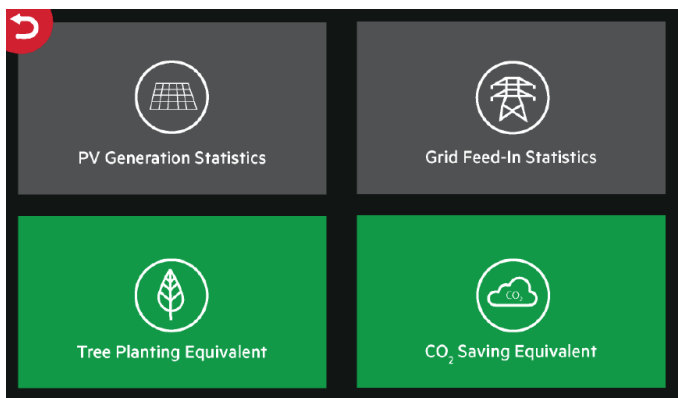

PV energy generation statistics

5.3.6 Checking Fault messages

If there is any fault during the AEG energy storage system operation, a blinking „Fault“ icon will appear in the right upper corner of the LCD screen. Clicking on the „Fault“ icon you will get information concerning the issue the system has incurred into.

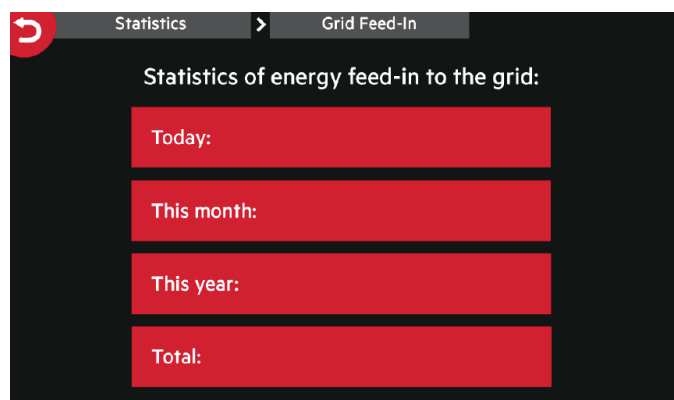

Grid feed-in statistics

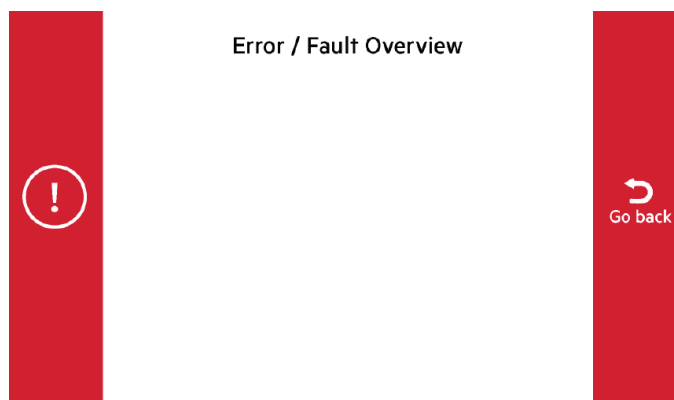

Fault overview

5.4 Advanced settings (for installers only)

Adjustments to „Advanced settings“ and „Reset settings“, as well as the following setups, should be carried out by the installer only. Please do not modify these settings unless you are a qualified system installer, otherwise damages to the product and possible injury might occur for which Solar Solutions explicitly cannot be held accountable for.

5.4.1 Setting of battery parameters

Installers can set the max. charging and discharging current values according to the actual needs. The checkboxes for „Use of battery V charged“ and „Smart lithium“ should be ticked.

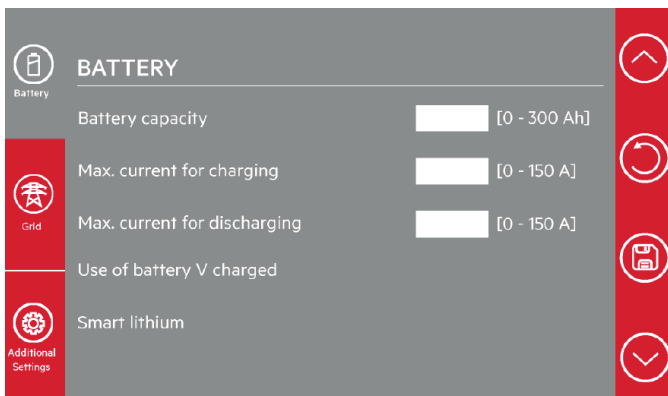

Setting of battery parameters

Specific Charging settings:

Generator charging:

- **Start voltage:** the generator will start when the battery voltage is less than the given „Start voltage“ value.
- **Current:** The generator will charge the battery with the given current value.

Grid charging:

- **Start voltage:** the grid will start charging the battery when the battery voltage is less than the given „Start voltage“ value.
- **Current:** The grid will charge the battery with the given current value.

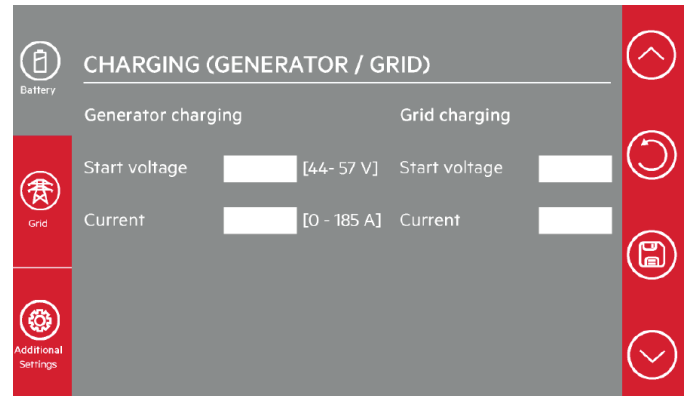

Specific charging (generator / grid)

Specific Discharging settings:

- **Shutdown:** the storage system will shut down if the battery voltage drops below the given value.
- **Low Battery:** the system will set off an alarm if the battery voltage drops below the given value
- **Restart:** the storage system will restart after shutdown at the given value.

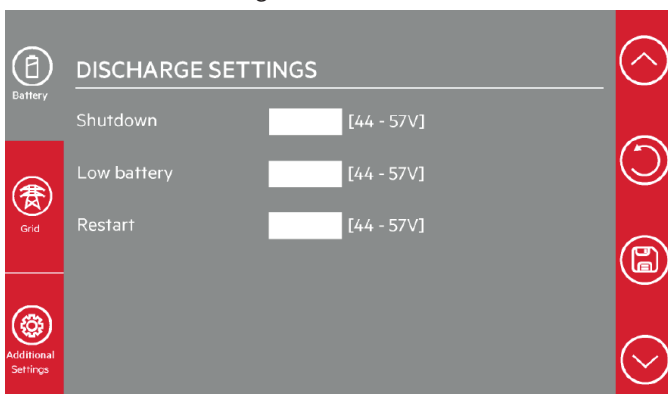

Specific discharge settings

5.4.2 Setting of grid parameters

To ensure a smooth operation of the AEG storage system with the grid, select the correct grid settings, which have to match with the local grid properties.

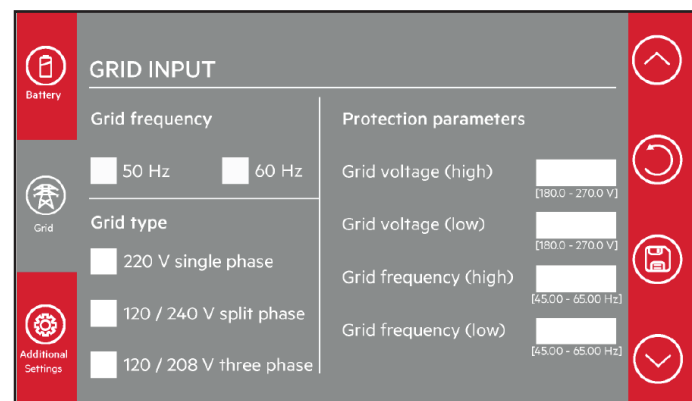

Grid input

Charging and Discharging settings of the AEG energy storage system

Note:

- If the option „House Load Only“ in the „Energy Utilization“ setting was chosen, do not tick „Grid sell“
- If the option „House Load Only & grid feed-in“ in the „Energy Utilization“ setting was chosen, please tick „Grid sell“
- Six periods can be set from 0:00 to 24:00
- **Grid sell:** the energy generated by the photovoltaic system powers the house loads and battery as priority; excess energy is sold back to the grid
- **Limited Power to Load:** check this box if the output power depends on the actual loads
- **Limited Power to Home:** check this box if the output power depends on the CT position.

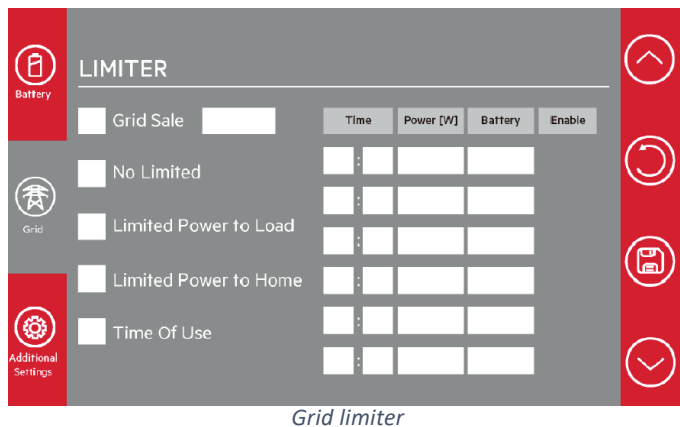

5.4.3 Additional settings

Additional information is accessible to the installer, such as the version of inverter hardware and software.

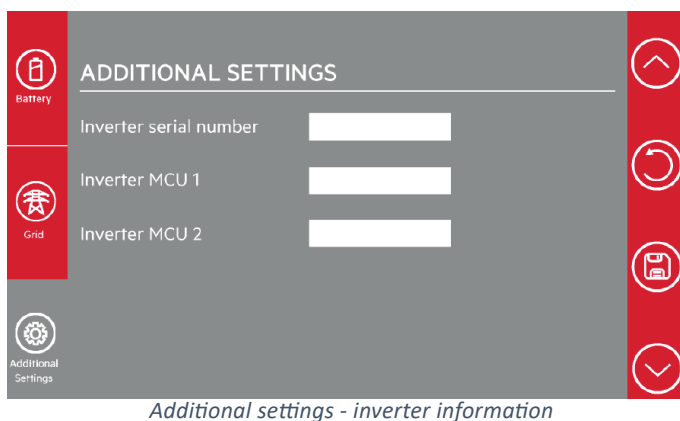

Solar Arc Fault on: this option is only available for the US market.

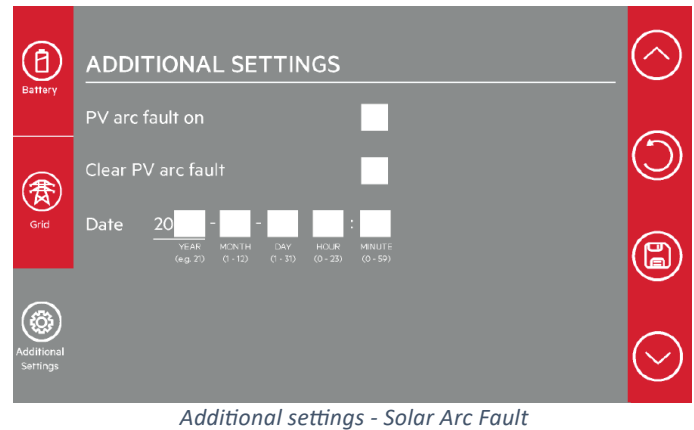

6. TROUBLESHOOTING

6.1 Battery pack warnings and troubleshooting

Check the indicators on the front to determine the state of the battery pack. A warning state is triggered when a condition, such as with voltage or current or temperature, reaches beyond design limitations.

The battery pack's BMS periodically reports its operating state to the inverter. When the battery pack parameters reach beyond the prescribed limits, the battery pack enters a warning state. When a warning is reported, the inverter immediately ceases to operate. The warning messages are shown in the display of the storage system.

The possible warning messages are:

- Battery Over Voltage
- Battery Under Voltage
- Battery Over Temperature
- Battery Under Temperature
- Battery Discharge Over Current
- Battery Charge Over Current

The abnormal state is cleared when the battery pack recovers normal operation.

6.2 Energy storage system warnings and troubleshooting

6.2.1 Fault codes

In case the AEG energy storage system incurs into an issue, this will be signaled by a warning on the LCD screen. Please find below the fault codes and the description of the associated issue. Should the issue not be cleared after restarting the system, please contact your installer / dealer.

Fault code	Fault information
F01	DC input polarity reverse fault
F02	DC insulation impedance permanent fault
F03	DC leakage current fault
F04	Ground fault GFID (battery end grounding)
F05	Read the memory error
F06	Write the memory error
F07	GFDI Blown Fuse
F08	GFDI Grounding contact failure
F09	IGBT damage by excessive drop voltage
F10	Auxiliary switch power supply failure
F11	AC main contactor errors
F12	AC auxiliary contactor errors
F13	
F14	DC firmware overcurrent malfunction
F15	AC firmware overcurrent malfunction
F16	GFCI(RCD) AC leakage current fault
F17	Three phase current, over-current fault
F18	AC over current fault of hardware
F19	All hardware failure synthesis
F20	DC over current fault of the hardware
F21	DC leakage flow fault
F22	Crash stop (if there is a stop button)
F23	AC leakage current is transient over current
F24	DC insulation impedance failure
F25	DC reverse irrigation failure

F26	The DC bus is unbalanced
F27	DC end insulation error
F28	Inverter 1 DC high fault
F29	AC load switch failure
F30	AC main contactor failure
F31	AC secondary contactor failure
F32	Inverter 2 DC high fault
F33	AC Current over current
F34	AC Overload
F35	AC Grid Unavailable fault
F36	AC grid phase error
F37	AC three-phase voltage imbalance failure
F38	AC three phase current unbalanced failure
F39	AC Over current failure
F40	DC Over current failure
F41	AC Line W,U over voltage
F42	AC Line W,U low voltage
F43	AC Line W,V over voltage
F44	AC Line W,V low voltage
F45	AC Line U,V over voltage
F46	AC Line U,V low voltage
F47	AC Over frequency
F48	AC Low frequency
F49	Phase U grid current DC current high
F50	Phase V grid current DC current high
F51	Phase W grid current DC current high
F52	AC inductor A, Phase current DC current high
F53	AC inductor B, Phase current DC current high
F54	AC inductor C, Phase current DC current high
F55	DC bus voltage is too high
F56	DC bus voltage is too Low
F57	AC reverse irrigation
F58	AC grid U over current
F59	AC grid V over current
F60	AC grid W over current

F61	Reactor A phase current high
F62	Reactor B phase current high
F63	Reactor C phase current high
F64	IGBT Heat sink high temperature

6.2.2 Troubleshooting specific faults

Below is a description of possible solutions to troubleshoot specific faults. If the problem persists, please contact your installer / distributor.

Fault code	Description	Possible solution
F13	Working mode change	Inverter work mode changed. 1 - Wait for a minute and check. 2- If the problem persists, please contact your installer / distributor
F18	AC overcurrent fault of hardware	AC side over current fault 1 - Please check whether the backup load power and common load power are within the range; 2 - Restart and check whether it is in normal; 3 - If the problem persists, please contact your installer / distributor
F20	DC overcurrent fault of the hardware	DC side overcurrent fault 1 - Check the connection between the PV plant and the storage system. 2 - Turn off the DC switch and the AC switch. Wait one minute, then turn on the DC/ AC switch again; 3 - If the problem persists, please contact your installer / distributor

Fault code	Description	Possible solution
F23	AC leakage current is transient over current	Leakage current fault 1 - Check the cable of PV module and inverter; 2 - Restart the inverter 3 - If the problem persists, please contact your installer / distributor
F24	DC insulation impedance failure	PV isolation resistance is too low. 1 - Check if the connection of PV panels and inverter is tight and correct; Check whether the PE cable of inverter is connected to ground; 2 - If the problem persists, please contact your installer / distributor
F26	The DC busbar is unbalanced	1 - Please wait for a while and check whether it is normal; 2 - If it is still the same, turn off the DC switch and the AC switch and wait for one minute. Then turn on the DC/AC switch again. 3 - If the problem persists, please contact your installer / distributor
F35	No AC grid	No utility 1 - Please check the grid condition in your neighborhood. 2 - Check if the switch between the inverter and the grid is on or not 3 - If the problem persists, please contact your installer / distributor

Fault code	Description	Possible solution
F42	AC line low voltage	Grid voltage fault 1 - Check if the AC voltage is in the range of standard voltage in specification; 2 - Check whether the grid AC cables are firmly and correctly connected 3 - If the problem persists, please contact your installer / distributor
F47	AC overfrequency	Grid frequency out of range 1 - Check if the frequency is in the range of specification or not; 2 - Check whether the AC cables are firmly and correctly connected; 3 - If the problem persists, please contact your installer / distributor
F48	AC lower frequency	Grid frequency out of range 1 - Check if the frequency is in the range of specification or not; 2 - Check whether the AC cables are firmly and correctly connected; 3 - If the problem persists, please contact your installer / distributor
F56	DC busbar voltage is too low	Battery voltage low 1 - Check whether battery voltage is too low; 2 - If the battery voltage is too low, use the PV plant or the grid to charge the battery 3 - If the problem persists, please contact your installer / distributor

Fault code	Description	Possible solution
F63	Arc fault	1 - Arc fault detection is only for the US market 2 - Check the PV module cable connection and clear the fault 3 - If the problem persists, please contact your installer / distributor
F64	Heat sink high temperature failure	Heat sink temperature is too high 1 - Check whether the work environment temperature is too high; 2 - Turn off the inverter for 10 minutes and restart it again. 3 - If the problem persists, please contact your installer / distributor

7. GENERATOR AND AC COUPLING FUNCTION

The AEG energy storage system features AC coupling and diesel generator coupling. Should you wish to use this function, please contact your installer / distributor for further instructions.

8. PRODUCT END OF LIFE

Please return any electrical equipment that you no longer use to the collection points provided for their disposal. Information concerning where the equipment can be disposed of can be obtained from your local authorities.



The battery pack is suitable for recycling through a professional battery recycling company



The wheeled bin symbol on the AEG product labels means that the equipment shall be disposed of as special waste in accordance to the local regulations.

9. DISCLAIMER OF LIABILITY

The use of this manual and the conditions or methods of installation, operation, use and maintenance of this product are beyond Solar Solutions's control. Solar Solutions expressly disclaims liability for loss, damage, or expenses arising out of or in any way connected with such installation, operation, use or maintenance.

Solar Solutions will not be responsible for consequences caused by any of the following events:

- Damage caused by transportation.
- Storage conditions do not meet the requirements specified in the manual, resulting in product damage.
- Incorrect storage, installation, and use of the product.
- Product installation and operation performed by unqualified personnel.
- Failure to comply with the operation instructions and safety precautions set forth in this manual.
- Product installation or operation in extreme environments that are not covered in this manual.
- Product installation or operation in environments not specified in the related international standards
- Exceeding the operation range of the parameters listed in the product's technical specifications.
- Unauthorized product disassembly and modification, or modification of the product's software.
- Product damage caused by abnormal natural events (force majeure, such as lightning strikes, earthquakes, fires, storms, etc.)
- Warranty expiration without extension of the warranty period.

No responsibility is assumed by Solar Solutions GmbH for any infringement of patents or other rights of third parties which may result from the use of this product. No license is granted by implication or otherwise under any patent or patent rights.

10. CONTACT

Solar Solutions GmbH
Brückenstrasse 94
60594 Frankfurt am Main, Germany
www.aeg-industrialsolar.de
Mail: service@aeg-industrialsolar.de
Tel: +49 (0)69400500810

AEG is a registered trademark used under license from AB Electrolux (publ).

